

RCA

User's Guide

**Amplified
Outdoor Antenna
VHF•UHF•FM**

Designed for
elliptical DBS
satellite dish
antennas with
multi-satellite LNB
for sharp local
channel reception

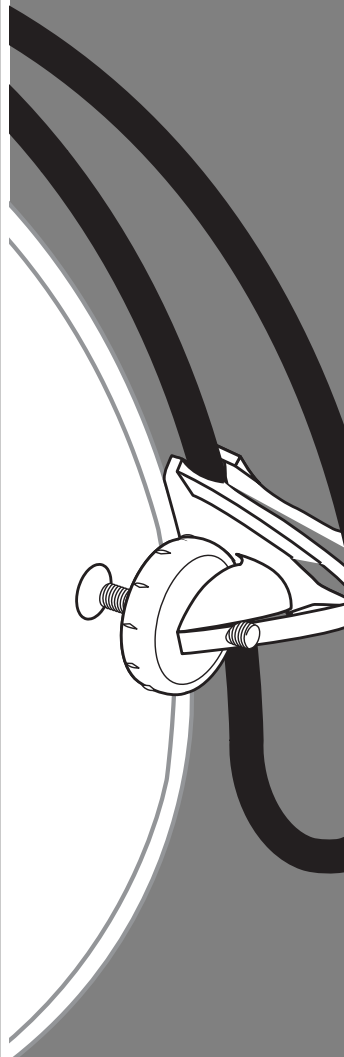

Limited One-Year Warranty

ANT3901

Table of Contents

Important Safety Precautions 3
Lightning Protection 3
About Your New ANT3901 Outdoor TV Antenna 4
 For Best Reception Results 4
Before You Begin 4
Installing Your New ANT3901 Antenna 5
 Step A: Installing the ANT3901 on Your Satellite Dish ... 5
 Step B: Installing the Inside Diplexers 8
 Step C: Setting Up Your TV to Use the ANT3901 9
Limited One-Year Warranty 10

WARNING! Use extreme caution when installing or removing an outdoor antenna that is located close to overhead wires such as power lines, telephone lines or cable TV lines. If any part of the antenna makes contact with overhead power lines, touching the antenna or the antenna cable can cause electrocution and death. If the antenna is in contact with any type of overhead wires, call your power company and ask them to send a qualified technician to remove the antenna. Do not attempt to remove it yourself!

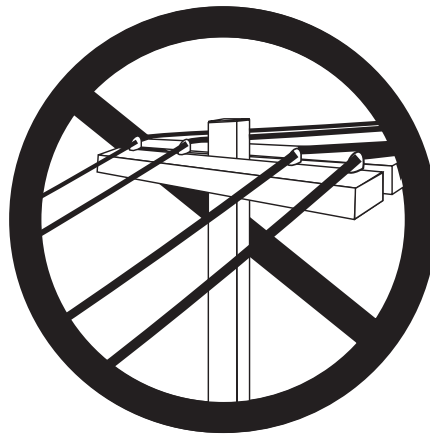

**RCA**

Important Safety Precautions

WARNING! Many do-it-yourself and professional antenna installers are injured or killed each year by electric shock. While anyone can see the obvious danger of falling, the most resourceful sometimes fail to recognize overhead wires as being potentially lethal. To touch any part of the antenna to these overhead wires is the same as touching the wires with your bare hand. A very serious shock is almost sure to result when contacting an electrical wire, and, in the case of primary wires on the tip of poles, the shock is similar to being struck by a bolt of lightning. Many power wires are within 20 to 25 feet of the ground and can easily be touched by an assembled antenna.

Please read and follow these important safety precautions.

- Get help from a qualified professional if removing an old antenna and there is any doubt of clearing overhead wires.
- Never install the antenna outdoors at night or in inclement weather conditions.
- Make sure the antenna downlead cable is connected to suitable lightning arrestors.
- Make sure the antenna installation is secure.

Lightning Protection

Always plug your TV and other electronic devices into a quality surge protector for maximum protection against lightning and power surges.

- Do not try to guess which overhead wires carry high voltage. Check with the power company.
- If you notice anything making contact with the overhead wires, call the power company to have it removed safely.
- Do not run the downlead cable over power lines.

All outdoor antenna installations should be properly grounded. To effectively protect the installations, the coaxial cable(s) should be grounded before they enter the house. The grounding of the coaxial cable is made using a "ground block" and copper wire (not supplied). For information, and the materials needed to ground your antenna installation, visit your local electronics store.

About Your New ANT3901 Outdoor TV Antenna

The ANT3901 is the perfect complement for a multi-beam satellite dish system. It picks up VHF and UHF signals so that you can enjoy local programming at no extra cost, along with your satellite programming.

The ANT3901 features an internal amplifier that minimizes signal loss. The DBS receiver powers the amplifier, so no additional power supply is required. Because ANT3901's antenna elements are manufactured to be weather-resistant, they'll perform at their best for many years to come.

For Best Reception Results

For the best reception results, the satellite dish and antenna combination should be high off the ground with minimal signal obstructions. On the side of your house (close to the roof), or on the roof itself generally offers the best environment for reception.

Remember, you can always rotate the antenna on the dish to adjust your reception.

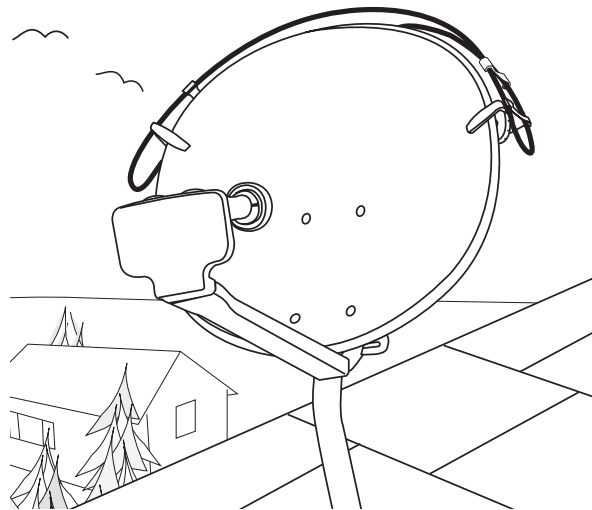

Before You Begin

Please take a moment to familiarize yourself with the various elements in the ANT3901 package. Please make sure that your package includes all of the necessary pieces (see Fig 1).

Installing Your New ANT3901 Antenna

The ANT3901 installation consists of three basic steps:

Step A: Installing the ANT3901 on your satellite dish.

Step B: Installing the inside diplexers.

Step C: Setting up your TV to use the ANT3901.

Please be sure to complete all of these steps before attempting to watch local channels with your ANT3901.

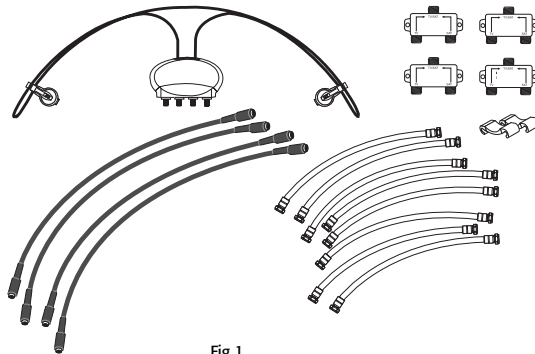

Fig 1

Step A: Installing the ANT3901 on your satellite dish

Note: Some satellite dishes have integrated multi-switches. The "TO RECEIVER" terminals are connected to the cables coming from the bottom of the dish. Treat these cables as the "TO RECEIVER" terminals of the multi-switch.

Note: For Dish Network owners; some Dish Network installations use smaller SW21 multi-switches. Treat these as one multi-switch with two "OUTPUT" or "TO RECEIVER" terminals.

1. Make sure all satellite receivers are turned off and unplugged from the electrical outlet.
2. Unsnap the antenna from the back notch of the mounting clamp (see Fig 2 on page 6).
3. Hold the antenna to the back of the dish so that the circular housing is centered with the RCA logo facing out (see Fig 4 on page 6).
4. Maneuver clamps over or around the edge of the dish one at a time (see Fig 3 on page 6).
5. Snap the antenna back into the back notch of the mounting clamp.
6. Tighten the clamps by turning the thumb-wheel screw clockwise.

Note: We recommend the use of the enclosed security clips for any dish. Snap the security clips onto the ANT3901 and slide down towards the mounting clips (see Fig 4 on page 6).

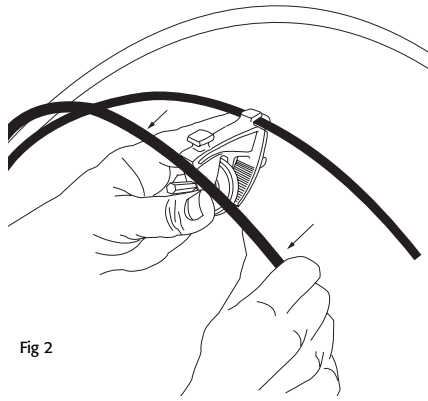

Fig 2

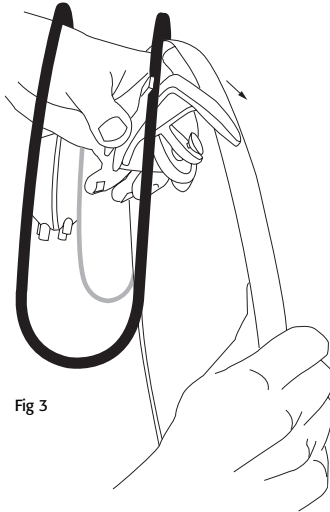

Fig 3

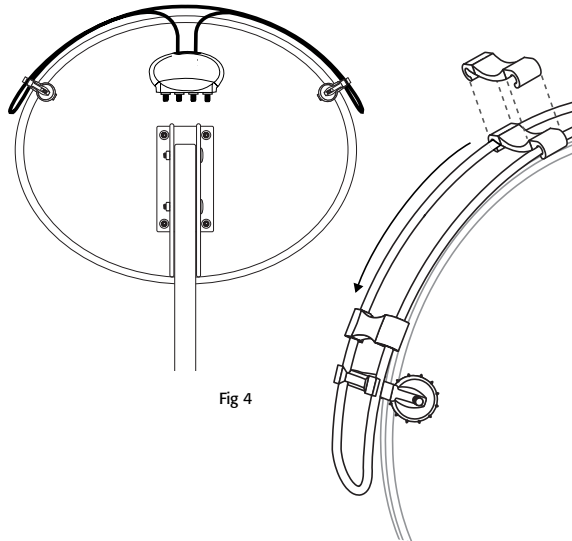
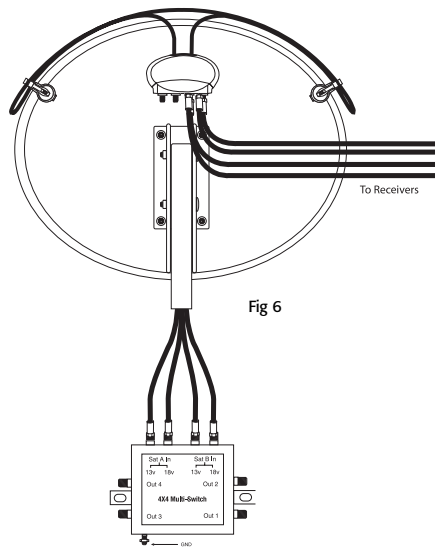
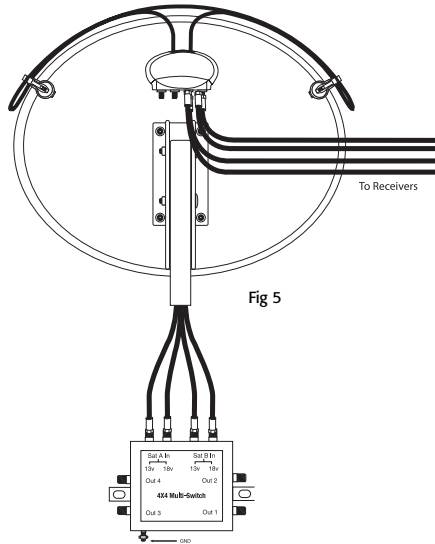

Fig 4

7. Disconnect the satellite cables from the "OUTPUT" or "TO RECEIVER" terminals on your multi-switch.
8. Connect the satellite cables to the "OUT" 1-4 terminals on the ANT3901 antenna (see Fig 5 on page 7).
9. Using the black 32" antenna cables, connect the "IN" 1-4 terminals of the ANT3901 to the "OUTPUT" or "TO RECEIVER" terminals on your multi-switch (see Fig 6 on page 7).
10. Continue to "Step B: Installing the Inside Diplexers" (on page 8) and follow the remainder of the standard installation procedure.



Step B: Installing the inside diplexers

1. Disconnect the satellite cable from the "SAT IN" terminal on your satellite receiver.
2. Connect the satellite cable to the terminal marked "TV/SAT" on the inside diplexer (see Fig 7 on page 8).
3. Connect one of the supplied white 12" connector cables from the terminal labeled "SAT" on the inside diplexer to your satellite receiver's "SAT IN" terminal (see Fig 8 on page 8).
4. Connect the other white 12" connector cable from the terminal labeled "TV" on the inside diplexer to your satellite receiver's "ANT IN" terminal (see Fig 9 on page 9).
5. Connect a coaxial cable (not supplied) from the satellite receiver's "TV OUT" terminal to your television or VCR (see Fig 10 on page 9).
6. Repeat step for each satellite receiver.
7. Continue to "Step C: Setting Up Your TV to Use the ANT3901" (page 9).

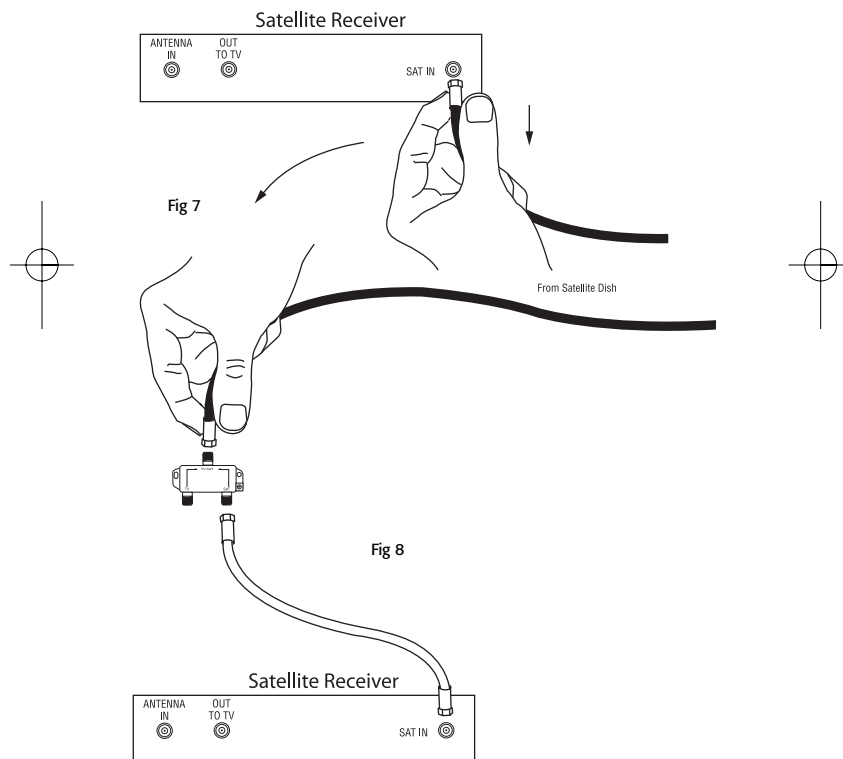

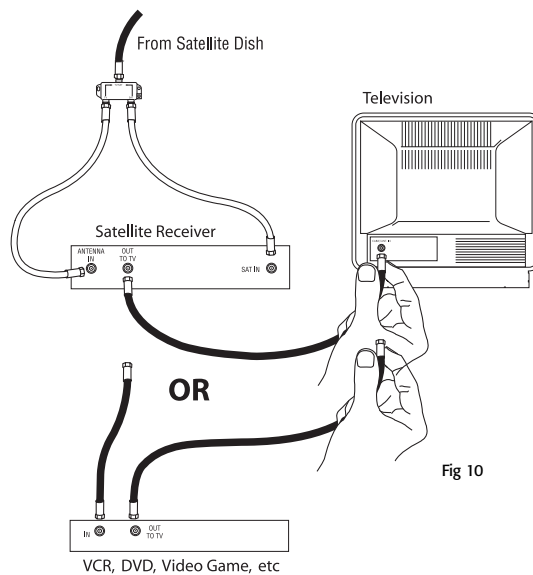
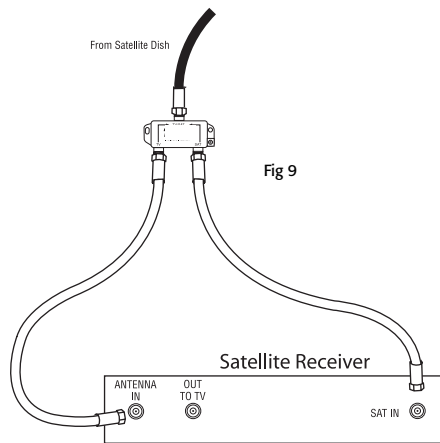

Step C: Setting up your TV to use the ANT3901

1. Access the menu of your TV and make sure the TV is in ANT/AIR mode and not CABLE/CATV mode. Please refer to your TV manual for the exact steps to change this option.
2. Access the menu of your TV and run the "Auto Channel Search" option. Please refer to your TV manual for the exact steps to change this option.
3. Turn on your DBS receiver and set to ANT, then tune your TV to your favorite channel.
4. To fine tune local channel reception, rotate the ANT3901 antenna around the perimeter of the dish until you receive the best possible picture. Tighten the clips so that the antenna is firmly secured to the satellite dish in that position.
5. The ANT3901 is now ready to receive local programming.

Note: Satellite receiver should be off to view local channels.

Limited One-Year Warranty

THOMSON INC. warrants that, for one year from date of purchase, it will replace this product if found to be defective in materials or workmanship. Return it postage prepaid to the Product Exchange Center, 11721 Alameda Ave., Socorro, TX 79927, for prompt, no-charge replacement with a current equivalent. This replacement is THOMSON INC.'s sole obligation under this warranty. THOMSON INC. will not be responsible for any incidental or consequential damages or for any loss arising in connection with the use or inability to use this product. Some states do not allow the exclusion or limitation of incidental or consequential damages, so the above limitation or exclusion may not apply to you. This warranty excludes defects or damage due to misuse, abuse or neglect. This warranty gives you specific legal rights, and you may also have other rights, which vary from state to state.

©2003 THOMSON INC.
10330 North Meridian Street
Indianapolis IN 46290
Made in China.

ANT3901 US IB REVA

Trademark(s) ®Registered.
Marca(s) Registrada(s).
www.rca.com

